

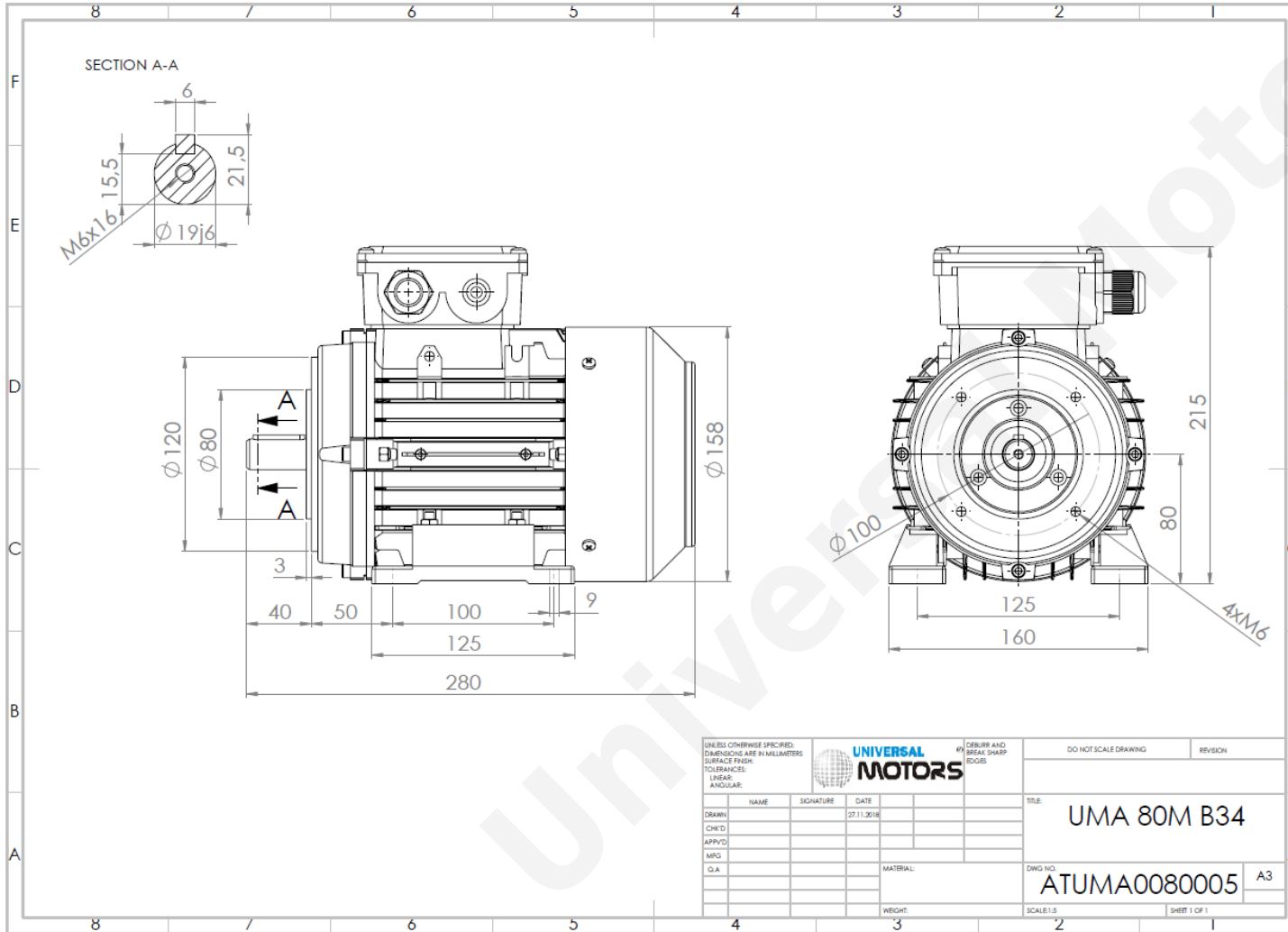

TECHNICAL DATA

Three Phase Electric Motors - Aluminum Frame
 UM2A 80M2-2
 1.5 kW / 2 Cv
 2880 RPM



Motor type:	UM2A 80M2-2
Output:	1.5 kW / 2 Cv
Speed (min ⁻¹):	2880 RPM
Frequency:	50 Hz
Voltage:	400 V
Current:	3.17 A
Power factor (Cos Ø):	0.84
Poles:	2
Insulation class:	F
Temperature rise Class:	B
Efficiency 50%:	80.4 %
Efficiency 75%:	82.0 %
Efficiency 100%:	81.3 %
Torque:	5.0 N.m
Tstarting/Tnominal:	2.9
Istarting/Inominal:	7.4
Tmaximum/Tnominal:	3.1
Noise:	70 Db(A)
Weight:	11.3 Kg
Brake AC:	AC3
Torque Brake DC:	8 N.m
Bearing DE:	6204 2Z
Bearing NDE:	6204 2Z
Torque Brake AC:	15 N.m
Brake DC:	REB-05-08

Regime - S1

Altitude - 1000m

Environment Temperature - 40°C

CONTACTS:

UNIVERSAL MOTORS Tel: +351 252 299 080
 Rua de São Brás,745 Fax: +351 252 299 089
 4480-782 VILA DO CONDE Mail: geral@universalmotors.pt

* References applied only in the UK